



DOKTALE
ROOFING SYSTEMS

MOST EXPERIENCED ROOFING BRAND

ENGINEERED TO PROTECT.



DOKTALE ROYAL

The new Doktale Royal Tile closely replicates the attractive low profile look of Asphalt Shingles with all the benefits of steel.

ROYAL TILE	TEXTURED
Overall Length	1340 mm
Length of Cover	1270 mm
Width of Cover	378 mm
Roof Cover/Tile	.48m2/Pc
Tiles/M2	2.08 Pc
Weight	2.5-3.5 Kg
Nailing Points Per Tiles	3
Minimum Roof Pitch	15 Deg

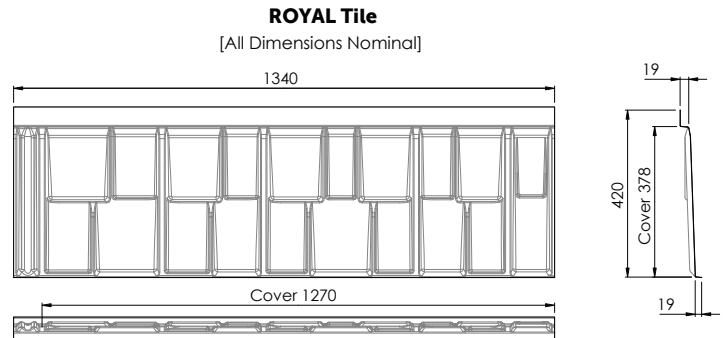

Tile Dimensions

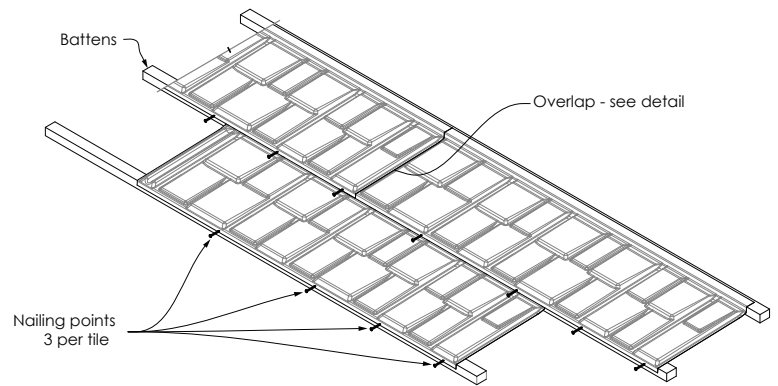

Nailing Detail

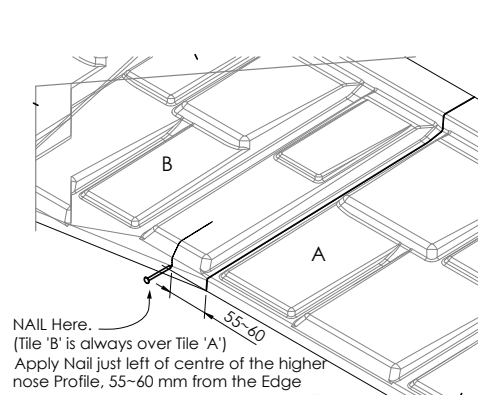

Overlap Detail

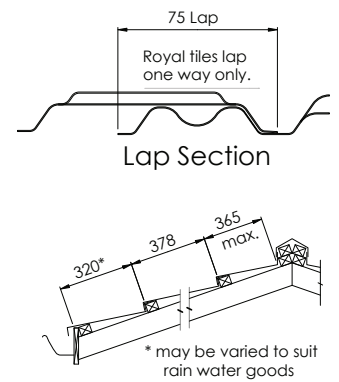

Batten Layout

DOKTALE PROVIDES THE VERY BEST PROTECTION IN ALL WEATHER CONDITIONS

ZINCALUME combines the corrosion protection of aluminium with the sacrificial protection of zinc, giving it the advantage of both metals. As a result ZINCALUME has a significantly longer service life than a galvanised steel product using only zinc.



Non Combustible
Class A Fire Rating



Lightweight
Easy Installation



Recyclable
Steel

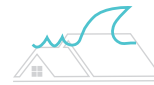

Marine Environments
Weatherproof Warranty*

ROYAL TEXTURED COLOUR OPTIONS

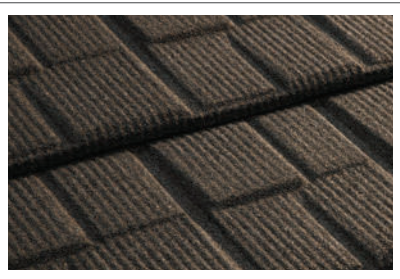

Charcoal



Walnut



Forest

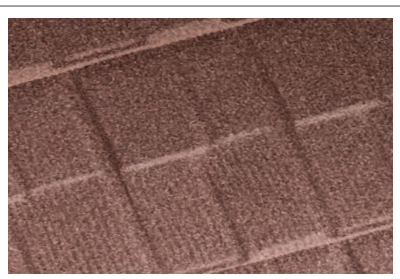

Coffee Brown



Mesquite



Weathered Timber

DOKTALE SHAKE

Available in Textured and Satin finishes the Doktale Shake has the rustic wood-grain appearance of traditional shakes with a deep-ribbed profile designed to provide strength, enhance shadow lines and create visual contrast. The Doktale Shake is the strongest metal tile profile available and offers significant foot traffic strength.

The aesthetic qualities of the Doktale Shake coupled with its strength and durability, has made it the first choice for building companies and architects alike. As with all Doktale roofs the lightweight benefits of steel roofing can offer considerable cost savings, while adding to the integrity of a building's structure.

SHAKE TILE	TEXTURED
Overall Length	1340 mm
Length of Cover	1260 mm
Width of Cover	368 mm
Roof Cover/Tile	.46m2/Pc
Tiles/M2	2.16 Pc
Weight	2.5-3.5 Kg
Nailing Points Per Tiles	3
Minimum Roof Pitch	15 Deg



SHAKE Tile

[All Dimensions Nominal]

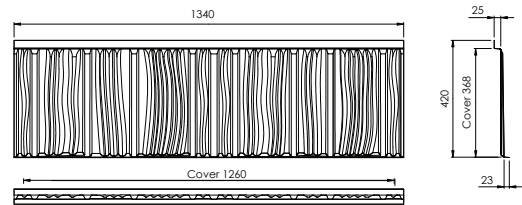

Tile Dimensions

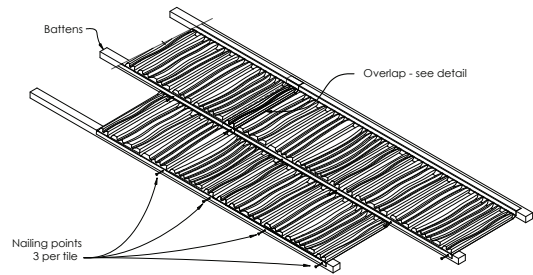

Nailing Detail

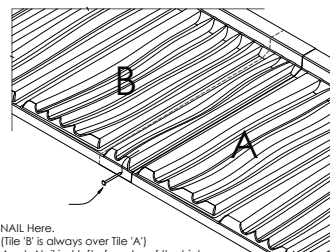

NAIL Here.
(Tile 'B' is always over Tile 'A')
Apply Nail just left of centre of the higher nose Profile, 55-60 mm from the Edge

Overlap Detail

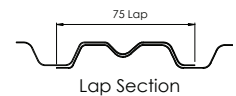

Lap Section

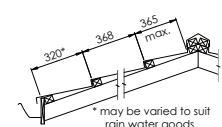

* may be varied to suit rain water goods

Batten Layout

DOKTALE OFFERS A WARRANTY YOU CAN RELY ON AND TRUST.



Doktale acrylic stone coating technology, pitched roofs and modular tile system allow it to offer its standard Satin and Textured Warranties in severe marine environments.

As a consequence, Doktale products and their Satin and Textured Weather Proof Warranties offer significant cost advantages over many pre painted products when used near the coast.

- Doktale Textured Tiles provide a natural "low glare" finish.
- There are no fading or "chalking" issues with Doktale Textured Tile.
- Doktale Textured Tiles are easily and cost effectively maintained.
- Doktale Textured Tiles produce less rain noise.

SHAKE TEXTURED COLOUR OPTIONS

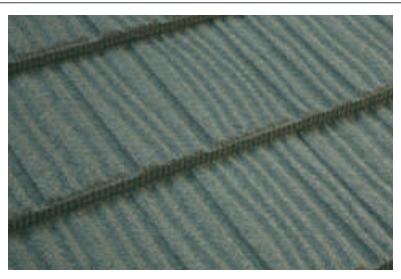

Greenstone



Coffee Brown

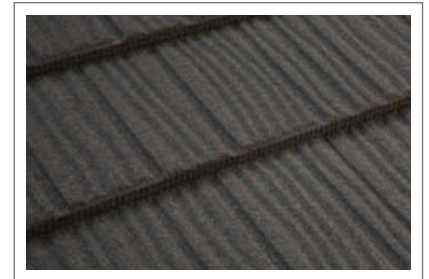

Charcoal

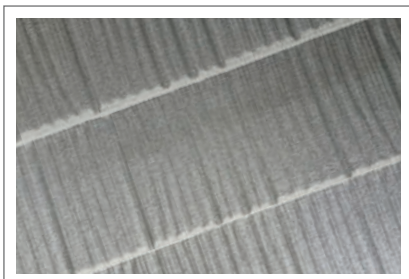

Silver Gray

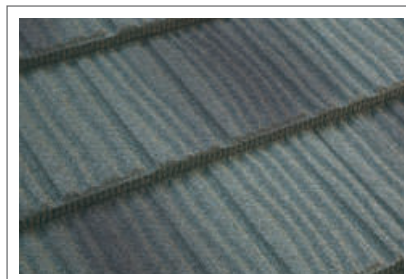

Forest

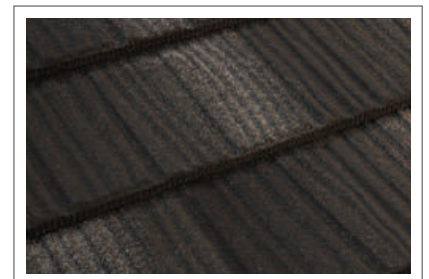

Mesquite

DOKTALE ROMAN

The distinct profile of the Mediterranean is reflected in the Doktale Roman Tile. The owner of this French provincial style home did considerable research to find that the Doktale Roman Tile was the most authentic design that offered all the benefits of lightweight durability.

There are two primary forces to contend with in roofing, weight and the forces of nature. Of all the roofing materials available steel is undoubtedly the strongest and yet is rated as a "lightweight roofing material".



DOKTALE PUTS YOUR FAMILY'S SAFETY FIRST

In fact a Doktale roof is approximately five times lighter than an equivalent concrete or clay tile roof. This alone can result in considerable cost savings as a heavier roof requires more structural support to meet the safety regulations in some countries.

Because each metal tile is fixed by horizontal fastenings into battens each individual tile is very secure. This gives integrity to the entire roof and prevents wind uplift issues. In high winds, some vertically fastened roofs, have literally been "Lifted Off" the frame by wind uplift pressure.

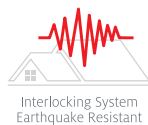

Of equal importance, is the attention given to the fixing Of roof battens to the rafters. A Doktale roof is engineered for very High Wind Zones (VHWZ), in coastal regions is proven around the world, to withstand extreme wind conditions.

ROMAN TEXTURED COLOUR OPTIONS



Lisbon

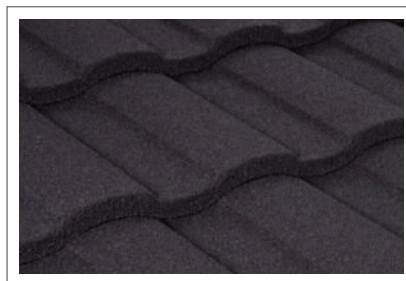

Charcoal

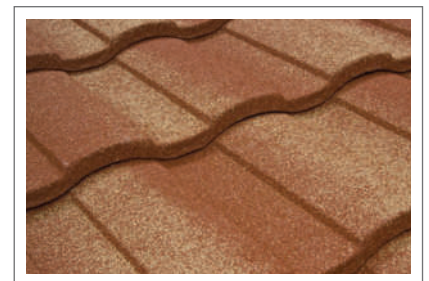

Sorrento



Firenze



Tuscany



Walnut

DOKTALE BOND

Replicates the traditional look of a concrete tile and is equally at home on both large estate homes and town houses.

You can never be certain that any building will withstand extreme natural disasters but you can be sure that a Doktale roof will withstand the extremes better than most, and we have over 28 years experience to prove it.



CHOOSING A DOKTALE ROOF PROVIDES MANY BENEFITS & PEACE OF MIND

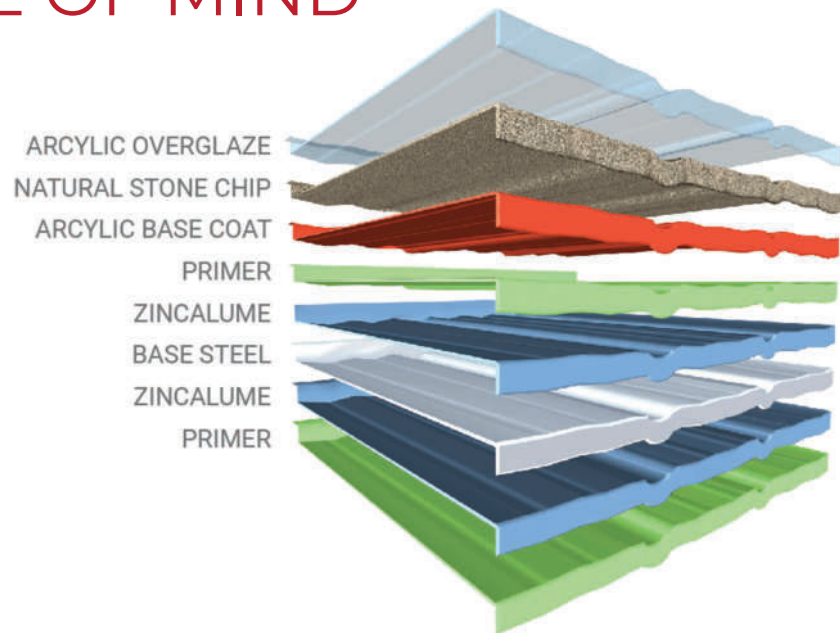

BOND TEXTURED COLOUR OPTIONS

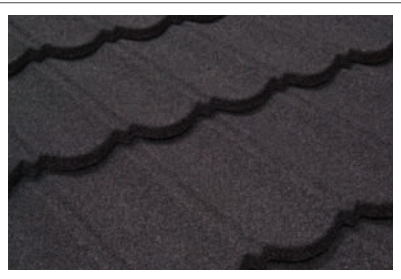

Charcoal



Silver Grey



Autumn



Brown Bark

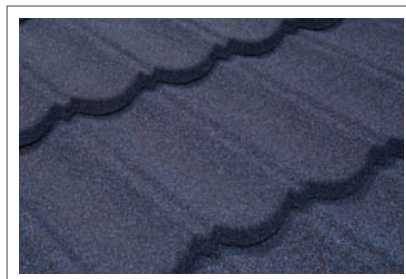

Midnight Blue



Terracotta

DOKTALE CLASSIC

The pressed ribs on the traditional Classic profile make for a strong and robust tile that is popular with many building companies.

We have learnt from the mistakes of others, for the need to be very thorough in the testing of profiles, paints and resins prior to manufacture. Small tolerances in design performance can make a big difference to the success and weather tightness of a product. Be sure that you choose a proven Company with a thorough track record in research and performance.



DOKTALE DESIGNED, RESEARCHED, TESTED & PROVEN

Doktaleprofiles have been tested and proven independent research facilities in numerous countries. From the most severe temperatures to hurricane force winds, fire, snow, torrential rains and more, Doktale has faced it all.



Hail Resistant
Freeze/Thaw Resistant



Non Combustible
Class A Fire Rating



High Wind Zones
Hurricane Resistant



UV Protection
Permanent Beauty



Recyclable
Steel

SUSTAINABLE AND ENVIRONMENTALLY CONSCIOUS.

Doktale is committed to being an environmentally responsible manufacturer. All of our products are produced from the world's most recycled building material steel. It is also standard practice that all off cuts and disused materials are collected on site and recycled, which leaves a clean and safe working environment for builders and home owners alike.

CLASSIC TEXTURED COLOUR OPTIONS

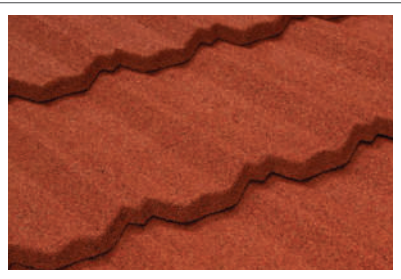

Terracotta



Brown Bark

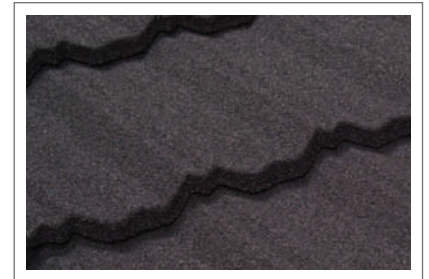

Charcoal

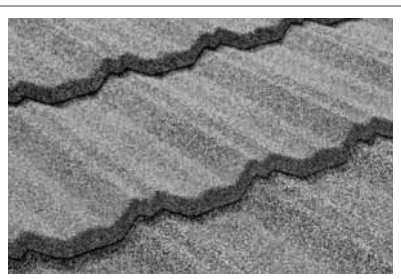

Slate

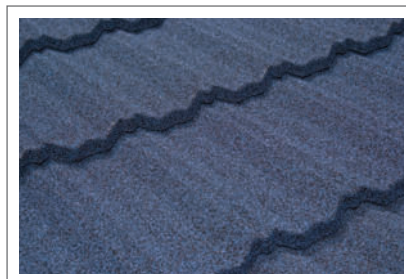

Midnight Blue

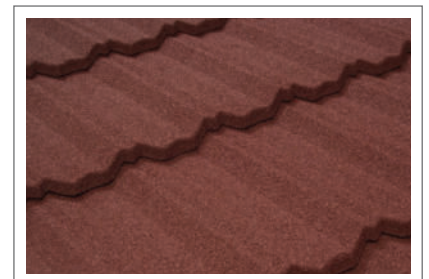

Burgundy

CHOOSING A DOKTALE ROOF PROVIDES MANY BENEFITS & PEACE OF MIND



Lightweight
Easy Installation

Lightweight: Doktale Steel Roof Tiles are a lightweight interlocking roof system, with uncompromising strength.



UV Protection
Permanent Beauty

Protection from the Sun: Doktale Roof Tiles incorporate "state of the art" acrylic coating technology and have been tested in one of the most severe UV climates in the world



Marine Environments
Weatherproof Warranty*

Marine Environments: Doktale roof tiles are suitable for all marine environments and are backed by our warranty.



Hail Resistant
Freeze/Thaw Resistant

Hail Resistance: Doktale Steel Roof Tiles achieve the highest UL 2218 rating for hail impact resistance in the United States.



Non Combustible
Class A Fire Rating

Fire Safe: Doktale Steel Roof Tiles are classified as a "Class A" Fire Rated, non combustible roofing material, in the United States.

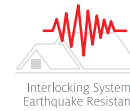

Interlocking System
Earthquake Resistant

Earthquake: Doktale Steel Roof Tiles are an interlocking roof system. The tiles are individually fixed and are less likely to fall through.



High Wind Zones
Hurricane Resistant

High Wind Resistance: Doktale Steel Roof Tiles are engineered to withstand high wind uplift forces and perform well in the "Very High Wind Zones" (VHWZ) of coastal Area.



Recyclable
Steel

Sustainability: Engineered from high grade Zincalume coated steel, a Doktale roof is one of the most recyclable and sustainable building products in the world.



50 Years Weather
Security Warranty*

Weather Security Warranty: Full 25 year weatherproof warranty plus a diminishing pro-rata weatherproof warranty for the subsequent 25 years.

Textured Surface Coating Warranty: Full 10 year surface coating warranty plus a diminishing pro-rata warranty for a further 10 years.

Satin Surface Coating Warranty: Full 5 year surface coating warranty plus a diminishing pro-rata warranty for a further 10 years.

DOKTALE
ROOFING SYSTEMS

AUTHORISED DISTRIBUTOR
KUDKYS STONE ARCH

NEAR TOLL GATE KUMBALAM, KOCHI
PH: +91 9745 477 777, +91 9745 477 771

www.doktale.com